

**NOTES**

- a. ALL DIMENSIONS ARE IN INCHES, [ ] = MM
- b. TERMINALS ARE CLOCKWISE FROM PIN #1

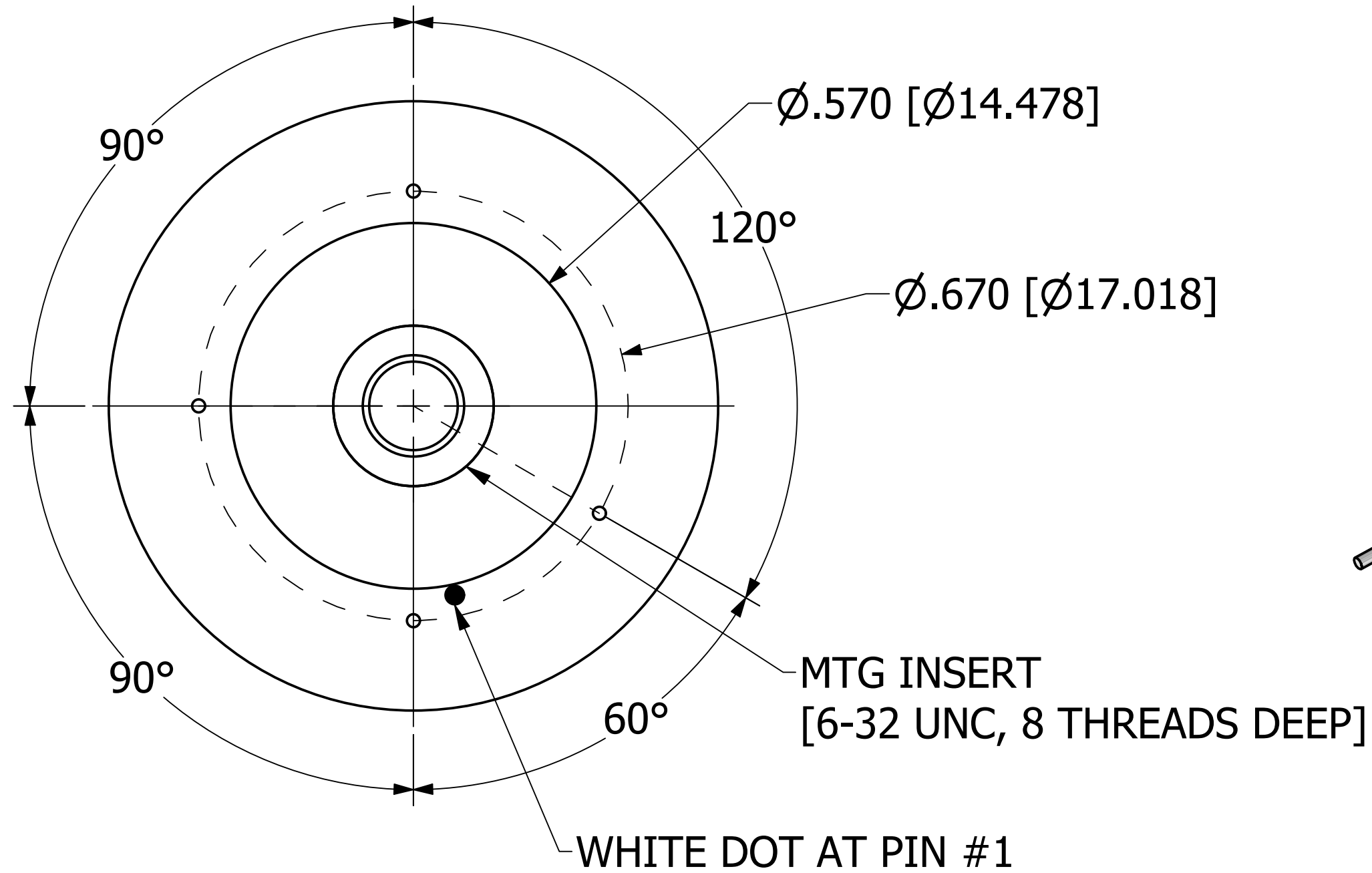

**BOTTOM VIEW**

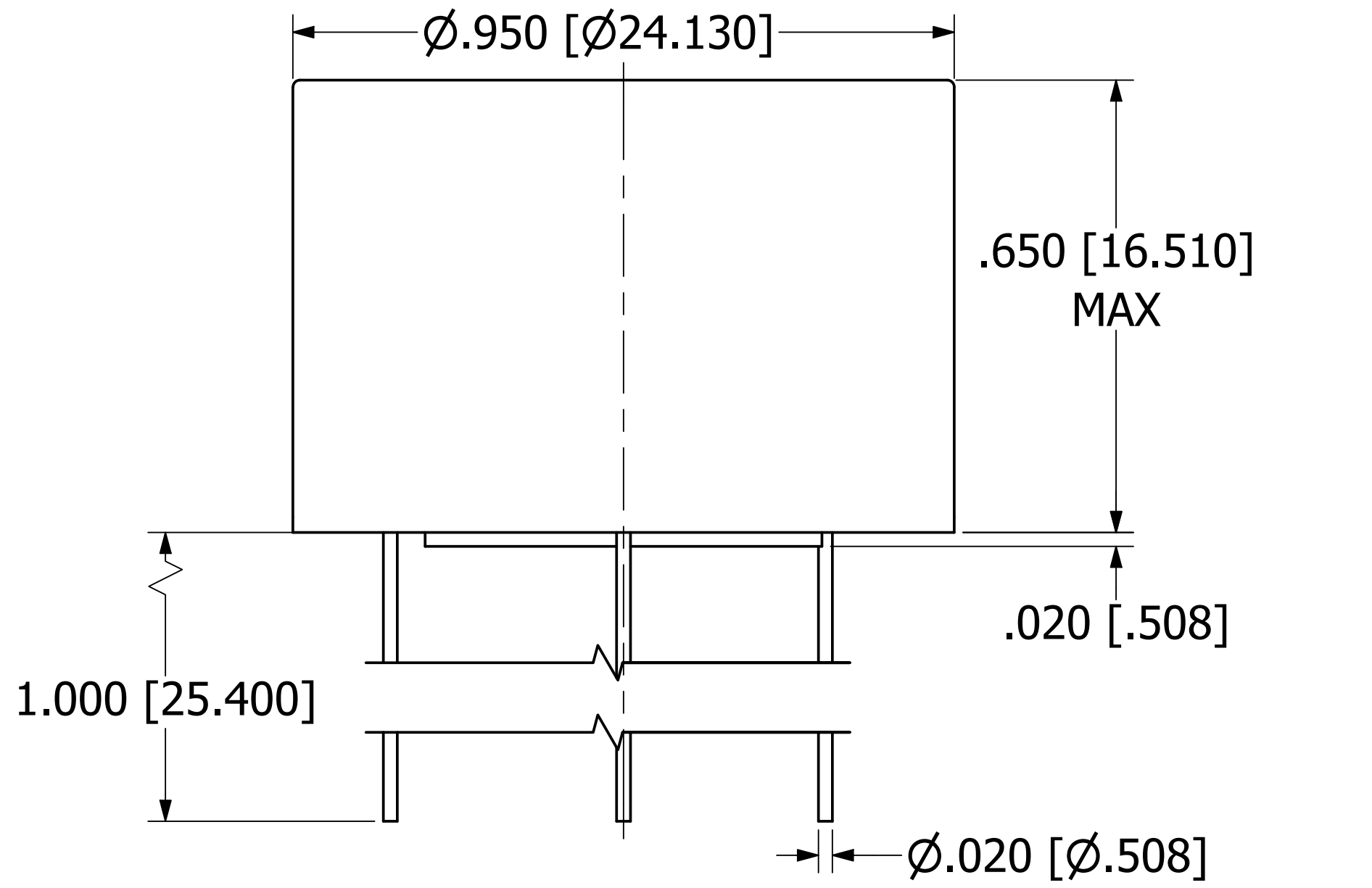
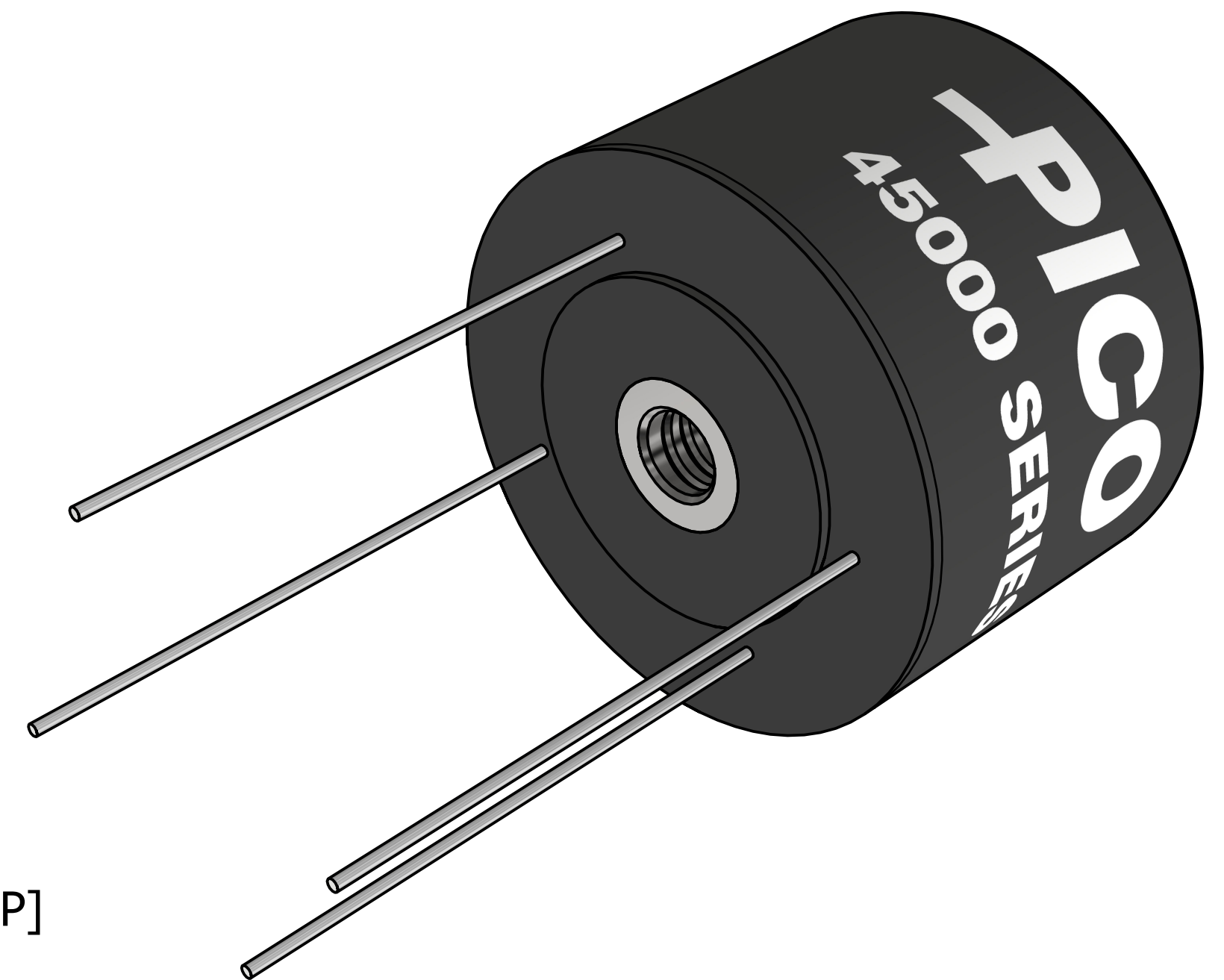

**PROPRIETARY AND CONFIDENTIAL**  
 THE INFORMATION CONTAINED IN THIS DRAWING IS THE SOLE PROPERTY OF  
 PICO ELECTRONICS INC. ANY REPRODUCTION IN PART OR AS A WHOLE WITHOUT THE WRITTEN  
 PERMISSION OF PICO ELECTRONICS INC. IS PROHIBITED

DRAWN	P.PALUCH	 143 Sparks Ave Village of Pelham, NY 10803		
CHECKED	H. VIDAURRE			
QA		<b>45000 SERIES</b>		
MFG				
APPROVED		SIZE	DWG NO	REV
REVISION DATE	06/06/2023	C		1
		SCALE	NTS	www.picoelectronics.com